

Removal of chromium from aqueous solutions by treatment with porous carbon electrodes: electrochemical principles

DANIEL GOLUB, YORAM OREN

Nuclear Research Center, Negev, Beer-Sheva, PO Box 9001, Israel 84190

Received 19 April 1988; revised 15 July 1988

The possibility of removing hexavalent chromium from waste water by electrochemical treatment using a graphite felt electrode and synthetic electrolytes is investigated. It is suggested that the process proceeds in two steps: electrochemical reduction of the hexavalent chromium to chromic ion followed by the formation of an insoluble chromic hydroxide in an electrochemically generated high pH environment. The chromic hydroxide adheres to the electrode surface as a charged colloidal particle. The electrochemical dissolution of the hydroxide layer by potential inversion is also discussed as a possible regeneration procedure.

It is concluded that these steps can be included within a single separating column provided that the feed pH and the column voltage are carefully controlled.

1. Introduction

Chromium has been shown in recent years to be highly toxic [1, 2], particularly in its hexavalent form. As a result, its concentration in ground water was limited by environmental protection authorities to 10 ppb [3]. The major sources for chromium contamination in ground water are chromium plating industries, disposed blowdown water from cooling towers (to which hexavalent chromium is added as a corrosion inhibitor) and timber treatment solutions which usually contain a mixture of chromate, arsenic and copper salts. Throughout the years, several procedures have been suggested for the treatment of chromium-containing waste solutions in order to reduce its concentration and to meet the tough regulations which, today, are more strictly enforced. Perhaps the most widely utilized process is the reduction of the chromate ion to trivalent chromium by reducing chemicals such as SO_2 , NaHSO_3 or ferrous sulphate. In some processes, ferrous ions are formed by an electrochemical oxidation of iron anodes [4, 5]. The chromic ion is then precipitated in settling ponds as a hydroxide by pH adjustment. Another version of this method, in which a magnetic field is used to stabilize a suspension of iron particles as a reducing agent, was recently suggested by the Actimag Co. (Scottsdale, Ariz.) [6].

The removal of chromium(VI) by non-electrochemical adsorption on activated carbon was studied by Huang and Wu [7]. In another article, the electro-deposition of chromium on a reticulated vitreous carbon electrode was studied [8]. The extent of metal removal after 10 passes through a potentiostatically controlled laboratory scale column was 51%, which is a rather poor efficiency if the utilization of the process

in large-scale units is considered. No explanation was provided by the authors for this low efficiency. However, this result is not surprising in view of the complex electrochemical activity revealed by chromium. It can be electrodeposited from solutions either as a metal or as a non-soluble ionic component (such as $\text{Cr}(\text{OH})_3$). For both forms to occur, the solution composition and the electrochemical conditions have to be carefully adjusted.

Perhaps some idea of the complexity of chromium electrochemistry can be gained from studies on the chromium electroplating process which, after almost a century of industrial use, is still not well understood. It is well established that chromium metal can only be deposited from Cr^{6+} solutions [9] probably by direct reduction to the metallic state [10]. Accordingly, it was shown that Cr^{3+} is strongly hydrated and the attached water molecules prevent further reduction [11]. It is also known that the anionic composition and the pH of the plating solution play an important role in the extent of reduction to the metallic form [12-15]. However, the exact mechanism by which anions act as a catalyzing factor in plating baths remains obscure [14].

In view of the complexity of chromium electrochemistry, and the ongoing search for an efficient process for chromium removal from wastes and industrial solutions, it is worth making efforts to increase the efficiency of electrochemical chromium reduction and removal. The present article is devoted to a study of the possibility of capturing hexavalent chromium by electrochemical means from solutions containing small (but hazardous) concentrations.

2. Experimental details

The work was done in a classical three-electrode

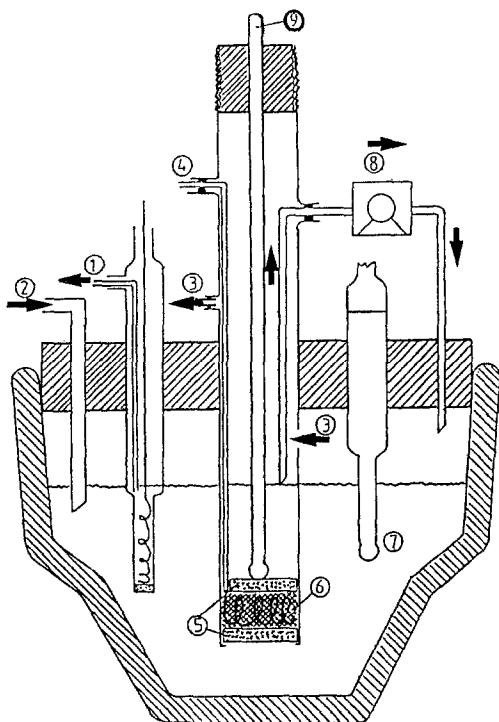

Fig. 1. Electrochemical cell: 1, auxiliary electrode; 2, Ar inlet; 3, Ar outlet; 4, gold wire; 5, sintered glass; 6, working electrode (graphite felt); 7, reference electrode; 8, peristaltic pump; 9, glass rod.

system using a mercury–mercurous sulphate reference electrode and a platinum wire separated by a frit glass as a counter electrode. To minimize interference of the counter electrode reaction products with the reactions occurring on the working electrode, the solution level in the counter electrode compartment was kept slightly below that in the cell by pumping it through a thin Teflon tube connected to a vacuum line. In this way the counter electrode compartment was constantly flushed with a fresh solution and accumulation of undesirable species was avoided.

Graphite felt, RVG-2000 (Le Carbon Lorrein, France) was used as a working electrode. This material has an approximate specific surface area of $1 \text{ m}^2 \text{ g}^{-1}$ and was shown [16, 17] to be highly efficient as an electrode for the removal of minute quantities of metallic as well as other contaminants. A felt disc, 4 mm thick and 10 mm in diameter was lightly pressed by a glass rod between two 3 mm thick sintered glass discs and mounted in a glass tube which was dipped in the solution. A gold wire served as a current collector. Since the electrode is bulky and was partially separated from the bulk solution by the sintered glass discs, provisions were made to circulate the solution through the electrode and to face it with a fresh solution whenever required. This was done by pumping the solution from the rear side of the electrode by a mini peristaltic pump and returning it to the main vessel as shown in Fig. 1.

Linear sweep voltammetry was applied, using an Opal (Israel) model 30–50 potentiostat and a PAR model 175 universal programmer.

Since chromium-contaminated waste solutions vary

in their composition and concentration depending on their source, synthetic solutions of potassium bichromate and chromic sulphate in the concentration range 5–100 ppm Cr with 0.5–1 N sodium sulphate as a supporting electrolyte were used. The pH of the solution was adjusted to the proper value by titration with NaOH or H_2SO_4 . The solutions were deaerated with pure argon prior to and during the experiments.

In a typical experiment the solution was circulated for several minutes through the working electrode at a flow rate of 2 ml min^{-1} under open circuit conditions, to ensure a complete replacement of the solution encased within the internal electrode volume. Then pumping was stopped and the potentiostatic linear voltage sweep was commenced. In some cases the electrode was flushed with a certain solution volume which was pumped out of the cell.

In essence, the working electrode assembly is equivalent to a thin layer electrochemical cell for two reasons. First, from the surface area to internal volume ratio of the felt, an average thickness of 50–100 μm can be estimated for the solution layer attached to an individual fiber and second, the relatively thick sintered glass discs supporting the graphite felt provide an efficient protection from diffusion of electroactive species into and from the internal solution volume within the duration of a single experiment (according to Einstein's expression, $x^2 = 2DT$, where x is the diffusion distance and D is the diffusion coefficient, the characteristic diffusion time, T , is 100 min whereas a typical voltage sweep takes about 10–20 min).

The thin layer electrochemistry technique was shown to be attractive for the study of complex electrochemical reactions [18, 19] as it is for the present study.

3. Results and discussion

3.1. Peak identification

Figure 2 shows a typical multicycle voltammogram taken in the potential range -1600 to $+400$ mV. In this range, only the reduction of chromium ionic species occurs. Accordingly, peak I at -600 mV is related to the reactions

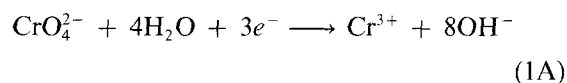

and

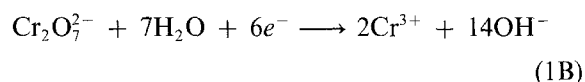

since in the pH range used, both the chromate and the dichromate ions are present in the solution.

Peak II at -950 mV is related to the reaction

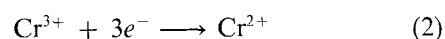

However, a certain degree of conversion of Cr^{2+} and Cr^{6+} to the metal may also occur in this range.

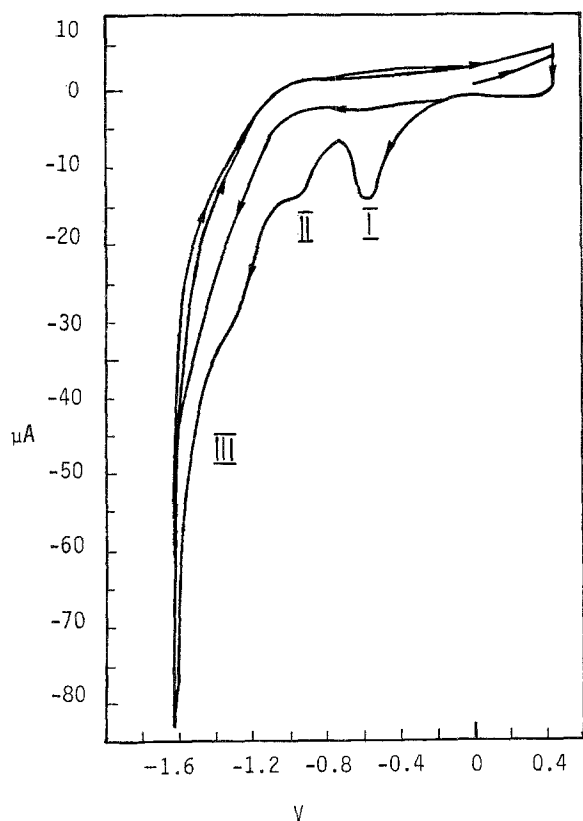
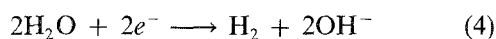

Fig. 2. Multicycle voltammogram taken in a solution of $2 \text{ mg dm}^{-3} \text{ CrO}_3$, $0.5 \text{ N Na}_2\text{SO}_4$ and $0.006 \text{ M H}_2\text{SO}_4$. Sweep rate 2 mV s^{-1} .

Peak III at -1300 mV is due to the reduction of H^+



The large increase in the current at very high cathodic potentials results from reduction of water according to



Identification of the peaks was made by taking a voltammogram with a solution containing only Cr^{3+} ions (Fig. 3) and the subsequent addition of Cr^{6+} . An important feature revealed in the last two figures is the gradual disappearance of all the peaks when the

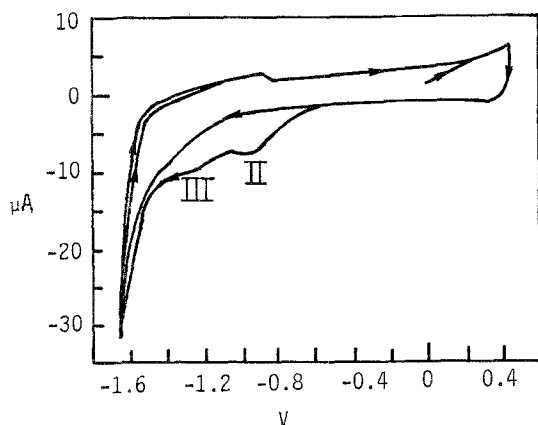

Fig. 3. Cyclic voltammogram taken in a solution of $10.8 \text{ mg dm}^{-3} \text{ Cr}_2(\text{SO}_4)_3 \cdot 8\text{H}_2\text{O}$, $1 \text{ N Na}_2\text{SO}_4$ and $10^{-3} \text{ M H}_2\text{SO}_4$. Sweep rate 2 mV s^{-1} .

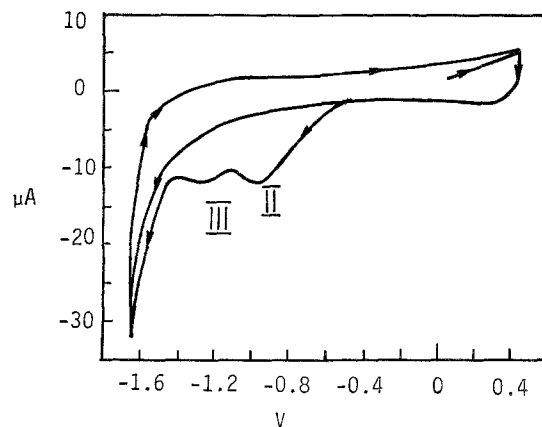

Fig. 4. Cyclic voltammograms taken in a solution of $1 \text{ N Na}_2\text{SO}_4$ and $10^{-3} \text{ M H}_2\text{SO}_4$ after exposure to cycles in a solution containing chromium followed by flushing. Sweep rate 2 mV s^{-1} .

voltammograms are repeated without changing the solution entrapped within the electrode. This behavior is due to the concentration decrease of chromium ionic components in the solution within the electrode as a result of the reactions mentioned above and according to the discussion that followed. This clearly shows that during an experimental run the felt electrode is completely isolated from the bulk solution in terms of diffusion of electroactive species. This confirms the estimations made in the experimental section and allows us to get more defined peaks and to make accurate charge efficiency calculations.

3.2. The state of chromium species in the electrode

It is now interesting to investigate the status of the chromium reduced species within the electrode. The importance of this point lies in the fact that reduction of Cr^{6+} ions is not necessarily sufficient for its complete removal from solutions and an additional mechanism for binding it to the electrode surface is required.

Perhaps the answer to this question is given in Fig. 4 which shows two consequent voltammograms taken in a solution which does not contain Cr^{3+} or Cr^{6+} ions, after flushing the electrode with a large volume of the same solution. This electrode was formerly exposed to many potential cycles in the cathodic range in solutions containing Cr^{6+} . The appearance of peak II at the first cycle shows the existence of an insoluble species attached to the electrode surface which dissolves slowly in the acidic solution used for flushing. Moreover, peak II does not appear in the voltammogram when the same procedure was applied to the electrode after washing it while under $+800 \text{ mV}$. At this potential the chromium components on the electrode surface are oxidized to Cr^{6+} , dissolved and washed out.

Figures 5a-c present a series of voltammograms taken in a stagnant solution having pH 5.4, after the following consequent treatments:

Case (1). Prior to taking the voltammogram shown in Fig. 5a, the electrode was flushed with the solution under $+800 \text{ mV}$. As noted above, at this potential all

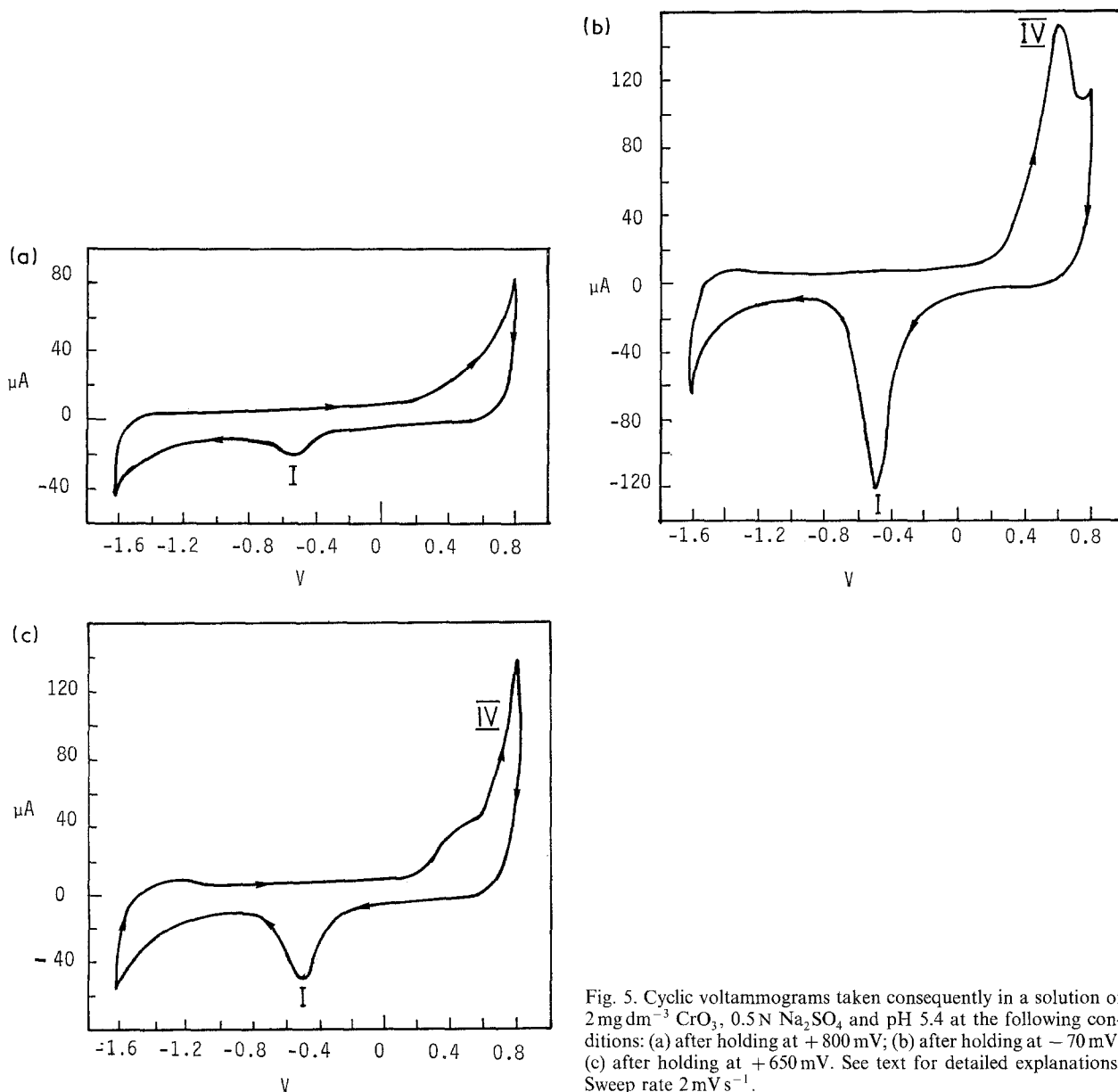

Fig. 5. Cyclic voltammograms taken consecutively in a solution of $2 \text{ mg dm}^{-3} \text{ CrO}_3$, $0.5 \text{ N Na}_2\text{SO}_4$ and pH 5.4 at the following conditions: (a) after holding at $+800 \text{ mV}$; (b) after holding at -70 mV ; (c) after holding at $+650 \text{ mV}$. See text for detailed explanations. Sweep rate 2 mV s^{-1} .

the chromium components are oxidized and washed out from the electrode.

Case (2). Prior to taking the voltammogram shown in Fig. 5b, the solution was circulated for about 5 min under -700 mV . At this potential the prominent reaction is the reduction of Cr^{6+} to Cr^{3+} .

Case (3). The voltammogram shown in Fig. 5c was taken after holding the potential at $+650 \text{ mV}$ for 15 min while circulating the solution. In contrast to case (1), the oxidized species are not washed out of the cell but kept in the entire bulk solution and within the electrode.

The absence of peaks II and III at -950 and -1300 mV , respectively (see Fig. 2) in all these cases should be noted. The former is certainly absent either due to the fact that at higher pH values the hydrated Cr^{3+} ion hydrolyses [20] or to the precipitation of the chromic ion as $\text{Cr}(\text{OH})_3$, which is faster at higher pH and prevents further reduction to Cr^{2+} . In view of the following discussion, the second mechanism appears more reasonable. The absence of the later peak is self evident in these pH conditions. The heights of

peaks I (-540 mV) and IV ($+620 \text{ mV}$) which are due to the $\text{Cr}^{3+}/\text{Cr}^{6+}$ reduction/oxidation reactions, respectively, seem to undergo significant changes. In case (1), these peaks are small and their height is equivalent to the concentration of electroactive species contained within the electrode volume. In fact, peak IV is indefinable (termed IP below) in this case because of its small size and the current accompanied with water decomposition which starts to increase significantly in this potential range.

The significant increase of peaks I and IV in case (2) is due to the accumulation of a chromium insoluble species within the electrode as the solution is circulated through it. Due to the relatively higher pH it is likely that this species is $\text{Cr}(\text{OH})_3$ formed according to

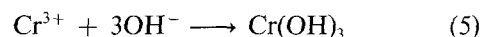

It should be noted that the potential sweep was first directed towards more cathodic and then to anodic values, thus allowing the oxidation of the electrode content as a first step (peak IV) and then its reduction (peak I).

Table 1. Peak current values (in μA) at different conditions. Solution: $2 \text{ mg dm}^{-3} \text{ CrO}_3$, $0.5 \text{ N Na}_2\text{SO}_4$

	Solution pH			
	5.4		3.5	
Peak	I	IV	I	IV
Case (1)	20	IP	20	34
Case (2)	122	152	68	96
Case (3)	52	45	24	IP

IP = indefinable peak.

The reduction of the peak sizes in case (3) is undoubtedly due to the oxidation of the Cr^{3+} in the deposit on the electrode to Cr^{6+} which is washed out of the electrode volume and diluted in the bulk solution.

Exactly the same procedure was applied to the electrode with a more acidic solution (pH 3.5). Peaks I and IV were found to be much smaller than those in the previous case.

In Tables 1 and 2 the peak currents and charge efficiencies, respectively found for the two pH values are compared. The calculation method and the significance of the various charge efficiencies given in Table 2 are the following.

(a) The total efficiency was calculated by dividing the charge consumed while circulating the solution through the electrode at -700 mV (case (2)), by the total chromium charge equivalent in the solution that followed through the electrode. This presents the charge efficiency for the reduction of hexavalent chromium content in the solution.

(b) The charge efficiency of peak I was calculated by dividing the current integral of peak I (Fig. 5b) by the charge consumed at -700 mV (case (2)). Since peak I presents the amount of chromium captured on the electrode, this expresses the efficiency for removing hexavalent chromium from the solution.

(c) This efficiency was calculated by dividing the charge consumed while circulating the solution through the electrode at $+650 \text{ mV}$ (case (3)) by that calculated from peak I. According to the significance of peak I as mentioned in (b) and to the fact that at this potential oxidation of the captured chromium species occurs, this may express the regeneration charge efficiency.

Following the results presented above it is suggested that chromium capturing proceeds in two stages:

Table 2. Charge efficiencies at different conditions. Solution: $2 \text{ mg dm}^{-3} \text{ CrO}_3$, $0.5 \text{ N Na}_2\text{SO}_4$

	Solution pH	
	5.4	3.5
(a) Total efficiency*	0.39	0.35
(b) From peak I*	0.91	0.36
(c) Regeneration*	0.92	-

* See text for explanation.

reduction of Cr^{6+} to Cr^{3+} followed by formation of $\text{Cr}(\text{OH})_3$ which adheres to the electrode matrix. Precipitation as chromic hydroxide is favorable if the cathodic potential range is limited to -1200 mV . At more negative potentials, metal electrodeposition may also take place. As mentioned in the Introduction, for this to occur, solution composition should be carefully adjusted, and even then current efficiency for this process may be very low [9]. To check this point, a graphite felt electrode, heavily coated with an electrodeposit obtained at almost the same conditions, was analysed by X-ray diffraction. No detectable chromium metal diffraction pattern was found. Moreover, it was found that the freshly prepared precipitate is readily and completely dissolved in dilute HCl, while an aged one can only be dissolved in dilute citric acid solution. This behavior is typical to chromic hydroxide which, upon ageing, is converted to its insoluble crystallographic gamma form. The results shown in Fig. 5 and Tables 1 and 2 suggest that a significant amount of hydroxide is accumulated on the cathodically charged electrode. As can be seen from Table 2, the charge efficiency for the reduction of chromate to chromic ion (total efficiency) is rather low and is not significantly affected by the pH over the range considered. It may be expected that the charge efficiency for this reaction will increase upon decreasing the pH [21]. However, comparing the sizes of peaks I and IV (case (2), Table 1) and the charge efficiency calculated from peak I (Table 2) reveals that there is a significant pH effect on the formation of the hydroxide. This is reasonable in view of the fact that by varying the pH from 3.5 to 5.4 the solubility of chromic hydroxide is reduced by several orders of magnitude [22]. Moreover, the hydroxide will be formed more efficiently if extreme cathodic potentials are applied. At about -1100 and -1400 mV for the solutions having pH 3.5 and 5.4, respectively, the cathodic current starts to increase significantly due to the reduction of water and H^+ (at the more acidic solution) according to reactions 3 and 5. Taking into account an average value for the current flowing in the potential ranges between these values and the cathodic edge of the sweep, the time that the electrode was exposed to these potentials and the volume of the solution in the electrode, it is possible to estimate a decrease by 3 orders of magnitude in H^+ concentration within the electrode at the first cycle after renewing the solution. This means that internal pH values as high as 6–8 (depending on the initial pH) are created. In this pH range chromic hydroxide has its lowest solubility [22], thus the best conditions for fast and efficient formation of the hydroxide are created. The low pH required for an efficient reduction contradicts the high pH which is needed for the formation of the hydroxide. Therefore, when a practical chromium removal procedure is considered, it is likely that the two processes will be carried out in separate electrochemical columns or in a single column within which an appropriate pH gradient is formed electrochemically.

3.3. The colloidal nature of chromium insoluble species

The adhesion strength of the hydroxide to the electrode surface is also affected by the pH of the solution. The electrical charge density of chromium hydroxide colloidal particles is pH sensitive and it was found [23] that the particles gain a zero zeta potential at pH 8.5. Since the electrode is negatively charged at the above-mentioned potential range and the pH of the solution within the electrode is, in any case, more acidic than this value (i.e. the hydroxide particles are positively charged), a strong adhesion to the electrode surface due to both electrostatic and van der Waals attractive interactions [24] may be expected.

3.4. Electrode bed regeneration

The size reduction of peak I after circulation of the solution at +650 mV (Table 1) and the high charge regeneration efficiency obtained at this potential (Table 2) clearly shows that an efficient electrochemical regeneration procedure can be applied to the loaded electrode bed. This point is undoubtedly important from the practical point of view, since by this means expensive and complicated chemical treatments can be avoided.

4. Conclusions

In essence, the mechanism proposed above for chromium removal does not differ from procedures described in the Introduction since all of them involve reduction of hexavalent chromium followed by deposition as chromic hydroxide at controlled pH conditions. However, according to the present study it is possible to include the two steps within a single electrochemical separating column and to achieve complete removal of hexavalent chromium provided that the potential and the pH of the solution are carefully controlled. Moreover, an electrochemical regener-

ation procedure of the electrode bed can be suggested. Such an all-electrochemical capturing-regeneration process is attractive because of the ease of handling and the fact that no addition of chemicals is necessary.

References

- [1] B. W. Morris, C. A. Hardisty, J. F. McCann, G. J. Kamp and T. W. May, *Atomic Spectrosc.* **6** (1985) 149.
- [2] R. A. Anderson, M. M. Polansky, N. A. Bryden, K. Y. Patterson, C. Veillon and W. H. Glinsmann, *J. Nutr.* **113** (1983) 276.
- [3] (a) 'International Standards for Drinking Water', 3rd edn, WHO, Geneva (1971). (b) 'European Standards for Drinking Water', 2nd edn, WHO Regional Office for Europe, Copenhagen (1970).
- [4] T. T. Taylor, *Chem. Eng. Progr.* **79** (1982) 70.
- [5] P. P. Bronovolokov and V. V. Pushkarev, *Zh. Prikl. Khim. (Leningrad)* **51** (1978) 1863.
- [6] J. Bishop, *Chem. Week* 11 February (1987) 14.
- [7] C. P. Huang and M. H. Wu., *Water Res.* **11** (1977) 673.
- [8] I. C. Agarwal, A. M. Rochon, H. D. Gesser and A. B. Sparling, *Water Res.* **18** (1984) 227.
- [9] F. A. Lowenheim (Ed.), 'Modern Electroplating', Chapman and Hall, London (1974).
- [10] F. Ogburn and A. Brenner, *J. Electrochem. Soc.* **96** (1949) 347.
- [11] J. P. Hant and H. Taub, *J. Chem. Phys.* **19** (1951) 602; **18** (1950) 757.
- [12] J. P. Hoare, *J. Electrochem. Soc.* **126** (1979) 190.
- [13] K. Nishimura, H. Fukushima, T. Akiyama and K. Higashi, *Metal Finish.* March (1987) 45.
- [14] J. Lin-Cai and D. Pletcher, *J. Appl. Electrochem.* **13** (1983) 245.
- [15] K. Othmer, 'Encyclopedia of Chemical Technology', Interscience Publishers, New York (1964) Vol. 5, p. 842.
- [16] Y. Oren and A. Soffer, *Electrochim. Acta* **28** (1983) 1649.
- [17] C. Zur and M. Ariel, *J. Appl. Electrochem.* **11** (1981) 639.
- [18] A. T. Hubbard, *J. Electroanal. Chem.* **22** (1969) 165.
- [19] A. T. Hubbard and F. C. Anson, in 'Electroanalytical Chemistry', Vol. 5 (edited by A. J. Bard), Dekker, New York (1971).
- [20] J. J. Lingane and R. L. Pecsok, *J. Am. Chem. Soc.* February (1949) 425.
- [21] G. Charlot, 'L'analyse Qualitative et les Reactions en Solution', Masson et Editeurs, Paris (1957).
- [22] D. Rai, B. M. Sass and D. A. Moor, *Inorg. Chem.* **26** (1987) 345.
- [23] J. E. Kolakowski and E. Matijevic, *J. Chem. Soc. Faraday Trans. 1* **75** (1979) 65.
- [24] H. Cohen, A. Soffer and Y. Oren, *J. Coll. Interf. Sci.* **120** (1987) 272.